

- ① - Configuration: selection of the operating mode.  $\overline{LS} / St / HS$  and the sensitivity range. **LS / St / HS**
  - ② - Sensitivity control potentiometer (%)
  - ③ - 'Number of levels' selector.
  - ④ - Time delay control potentiometer. **Tt**
  - ⑤ - Time delay status (yellow) LED. **Tt**
  - ⑥ - Power supply status (green) LED. **Un**
  - ⑦ - Relay output status (yellow) LED. **R**
  - ⑧ - 35 mm rail clip-in spring
- ① - Configuration : choix du mode de fonctionnement.  $\overline{LS} / St / HS$  et de la gamme de sensibilité. **LS / St / HS**
  - ② - Potentiomètre de réglage de la sensibilité (%)
  - ③ - Commutateur de sélection du nombre de niveaux.
  - ④ - Potentiomètre de réglage de la temporisation. **Tt**
  - ⑤ - LED d'état (jaune) de la temporisation. **Tt**
  - ⑥ - LED d'état (verte) de l'alimentation. **Un**
  - ⑦ - LED d'état (jaune) de la sortie relais. **R**
  - ⑧ - Ressort de clipsage sur rail de 35 mm
- ① - Konfiguration: Wahl des Betriebsmodus.  $\overline{LS} / St / HS$  und des Sensibilitätsbereichs. **LS / St / HS**
  - ② - Potentiometer zur Einstellung der Sensibilität (%)
  - ③ - Wahlschalter der Niveaunzahl.
  - ④ - Potentiometer zur Einstellung der Verzögerung. **Tt**

- ⑤ - Status-LED (gelb) der Verzögerung. **Tt**
  - ⑥ - Status-LED (grün) der Stromversorgung. **Un**
  - ⑦ - Status-LED (gelb) des Relaisausgangs. **R**
  - ⑧ - Klemmfeder auf 35 mm Schiene
- ① - Configuración: selección del modo de funcionamiento.  $\overline{LS} / St / HS$  y de la gama de sensibilidad. **LS / St / HS**
  - ② - Potenciómetro de ajuste de la sensibilidad (%)
  - ③ - Conmutador de selección del número de niveles.
  - ④ - Potenciómetro de ajuste de la temporización. **Tt**
  - ⑤ - LED de estado (amarillo) de la temporización. **Tt**
  - ⑥ - LED de estado (verde) de la alimentación. **Un**
  - ⑦ - LED de estado (amarillo) de la salida relé. **R**
  - ⑧ - Molla di aggancio su barra metallica da 35 mm
- ① - Configurazione: scelta della modalità di funzionamento.  $\overline{LS} / St / HS$  e della gamma di sensibilità. **LS / St / HS**
  - ② - Potenziometro di regolazione della sensibilità (%)
  - ③ - Commutatore di selezione del numero di livelli.
  - ④ - Potenziometro di regolazione della temporizzazione. **Tt**
  - ⑤ - LED di stato (giallo) della temporizzazione. **Tt**
  - ⑥ - LED di stato (verde) dell'alimentazione. **Un**
  - ⑦ - LED di stato (giallo) dell'uscita relé. **R**
  - ⑧ - Resorte de clipsado en carril 35 mm

▲ DANGER	▲ DANGER	▲ GEFAHR	▲ PELIGRO	▲ PERICOLO
<p><b>HAZARD OF ELECTRIC SHOCK, EXPLOSION OR ARC FLASH</b></p> <ul style="list-style-type: none"> <li>- Disconnect all power off before servicing equipment.</li> <li>- Confirm that the product power supply voltage and its tolerances are compatible with those of the network.</li> </ul> <p><b>Failure to follow these instructions will result in death or serious injury.</b></p>	<p><b>RISQUE D'ELECTROCUTION, D'EXPLOSION OU D'ARC ELECTRIQUE</b></p> <ul style="list-style-type: none"> <li>- Couper toutes les alimentations avant d'intervenir sur cet appareil.</li> <li>- Assurez-vous que la tension d'alimentation du produit, avec ses tolérances, est compatible avec celle du réseau.</li> </ul> <p><b>Le non-respect de ces instructions entraînera le mort ou des blessures graves.</b></p>	<p><b>STROMSCHLAG-, EXPLOSIONS- ODER LICHTBOGENGEFAHR</b></p> <ul style="list-style-type: none"> <li>- Vor dem Arbeiten an dem Gerät dessen Stromversorgung abschalten.</li> <li>- Stelle Sie sicher, dass die Versorgungsspannung des Produkts einschließlich Toleranzen mit den Netzbedingungen vereinbar ist.</li> </ul> <p><b>Die Nichtbeachtung dieser Anweisungen wird den Tod oder schwere Körperverletzung zur Folge haben.</b></p>	<p><b>RIESGO DE ELECTROCUCIÓN, EXPLOSIÓN O ARCO ELÉCTRICO</b></p> <ul style="list-style-type: none"> <li>- Desconecte toda alimentación antes de realizar el servicio.</li> <li>- Asegúrese de que la tensión de alimentación del producto y sus tolerancias son compatibles con las de la red eléctrica.</li> </ul> <p><b>Si no se siguen estas instrucciones, provocará lesiones graves o incluso la muerte.</b></p>	<p><b>RISCHIO DI SCOSSA ELETTRICA, DI ESPLOSIONE O DI OFTALMIA DA FLASH</b></p> <ul style="list-style-type: none"> <li>- Scollegare l'apparecchio dalla presa di corrente prima di qualsiasi intervento.</li> <li>- Assicurarsi che la tensione di alimentazione del prodotto e le relative tolleranze sia compatibile con quelle della rete.</li> </ul> <p><b>Il mancato rispetto di queste istruzioni provocherà morte o gravi infortuni.</b></p>
▲ WARNING	▲ AVERTISSEMENT	▲ WARNUNG	▲ ADVERTENCIA	▲ AVVERTENZA
<p><b>UNINTENDED EQUIPMENT OPERATION OR INADEQUATE OVERCURRENT PROTECTION</b></p> <ul style="list-style-type: none"> <li>- Do not use in safety critical system.</li> <li>- Do not disassemble, repair or modify the product.</li> <li>- Install the product in the operating environment conditions described in this document.</li> <li>- Install properly rated fuses as recommended in this document.</li> </ul> <p><b>Failure to follow these instructions can result in death, serious injury, or equipment damage.</b></p>	<p><b>FONCTIONNEMENT INATTENDU DE L'EQUIPEMENT OU PROTECTION CONTRE LA SURINTENSITE INCORRECTE</b></p> <ul style="list-style-type: none"> <li>- Ne pas utiliser dans un système où la sécurité est critique.</li> <li>- Ce produit ne doit être ni démonté, ni réparé ni modifié.</li> <li>- Installez le produit dans les conditions d'environnement d'exploitation, comme indiqué dans les fusibles appropriés.</li> <li>- Installer des fusibles appropriés conformément aux recommandations du présent document.</li> </ul> <p><b>Le non-respect de ces directives peut entraîner la mort, des lésions corporelles graves ou des dommages matériels.</b></p>	<p><b>UNBEABSICHTIGTER GERÄTEBETRIEB ODER UNANGEMESSENER ÜBERSpannungSSCHUTZ</b></p> <ul style="list-style-type: none"> <li>- Verwenden Sie das Produkt nicht in sicherheitskritischen Systemen.</li> <li>- Das Produkt darf weder zerlegt noch repariert oder verändert werden.</li> <li>- Installieren Sie das Produkt in einer Betriebsumgebung, die den in diesem Dokument beschriebenen Betriebsumgebungsbedingungen entspricht.</li> <li>- Installieren Sie Sicherungen mit geeigneten Nennwerten gemäß den Empfehlungen in diesem Dokument.</li> </ul> <p><b>Die Nichtbeachtung dieser Anweisung kann den Tod, Körperverletzung oder Materialschäden zur Folge haben.</b></p>	<p><b>FUNCIONAMIENTO IMPREVISTO DEL EQUIPO O PROTECCIÓN INADECUADA CONTRA SOBRECORRIENTE</b></p> <ul style="list-style-type: none"> <li>- No utilizar en sistemas críticos para la seguridad.</li> <li>- No desmonte, repare ni modifique este productos.</li> <li>- Instale el producto en las condiciones de entorno de funcionamiento descritas en este documento.</li> <li>- Instale fusibles con los valores nominales adecuados que se recomiendan en este documento.</li> </ul> <p><b>Si no se respetan estas precauciones pueden producirse graves lesiones, daños materiales o incluso la muerte.</b></p>	<p><b>FUNCIONAMENTO IMPREVISTO DELL'APPARECCHIATURA O PROTEZIONE INADEGUATA DALLA SOVRACORRENTE</b></p> <ul style="list-style-type: none"> <li>- Non utilizzare in un sistema critico per la sicurezza.</li> <li>- Non smontare, riparare o modificare il prodotto.</li> <li>- Installare il prodotto nelle condizioni ambientali di funzionamento descritte nel presente documento.</li> <li>- Installare fusibili con valore nominale adeguato, come indicato nel presente documento.</li> </ul> <p><b>La mancata osservanza di questa precauzione può causare gravi rischi per l'incolumità personale o danni alle apparecchiature.</b></p>
<p>Electrical equipment should be installed, operated, serviced, and maintained only by qualified personnel. No responsibility is assumed by Schneider Electric for any consequences arising out of the use of this material.</p>	<p>Les équipements électriques doivent être installés, exploités et entretenus par un personnel qualifié. Schneider Electric n'assume aucune responsabilité des conséquences éventuelles découlant de l'utilisation de cette documentation.</p>	<p>Elektrische Geräte dürfen nur von Fachpersonal installiert, betrieben, gewartet und instand gesetzt werden. Schneider Electric haftet nicht für Schäden, die aufgrund der Verwendung dieses Materials entstehen.</p>	<p>Sólo el personal de servicio cualificado podrá instalar, utilizar, reparar y mantener el equipo eléctrico. Schneider Electric no asume las responsabilidades que pudieran surgir como consecuencia de la utilización de este material.</p>	<p>Le apparecchiature elettriche devono essere installate, usate e riparate solo da personale qualificato. Schneider Electric non assume nessuna responsabilità per qualunque conseguenza derivante dall'uso di questo materiale.</p>

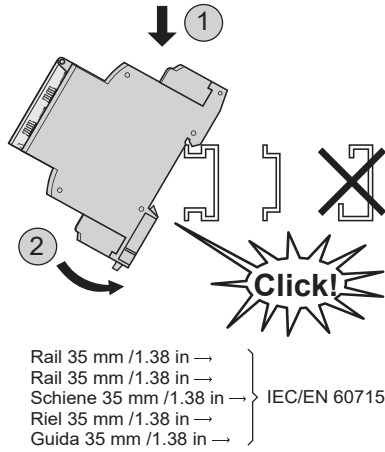

Rail 35 mm / 1.38 in →  
 Rail 35 mm / 1.38 in →  
 Schiene 35 mm / 1.38 in →  
 Riel 35 mm / 1.38 in →  
 Guida 35 mm / 1.38 in →

IEC/EN 60715

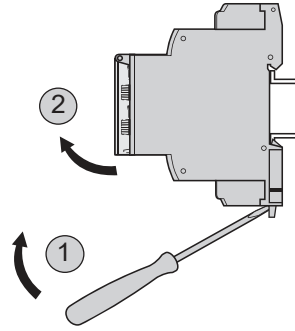

$\frac{\text{mm}}{\text{in.}}$	$\frac{6}{0.24}$				
mm <sup>2</sup>		0.5...3.33	0.5...2.5	0.2...2.5	0.2...1.5
AWG		20...12	20...14	24...14	24...16
	Ø 3.5 mm/ 0.14 in		N·m	0,6...1	
			lb-in	5.3...8.8	

Typical value				
— 24 V	2 x 5 A	100 000	2 x 1 A	100 000
~ 24 V	2 x 5 A	100 000	2 x 2 A	100 000
~ 250 V max	2 x 5 A	100 000	2 x 2 A	100 000

Installation conditions / Conditions d'installation / Installationsbedingungen / Condiciones de instalación / Condizioni d'installazione

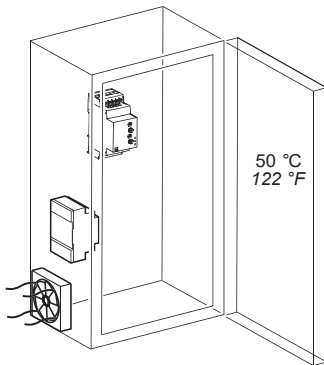

Power factor 100 %  
 Facteur de marche 100 %  
 Einschaltdauer 100 %  
 Factor de marcha 100 %  
 Fattore di potenza 100 %

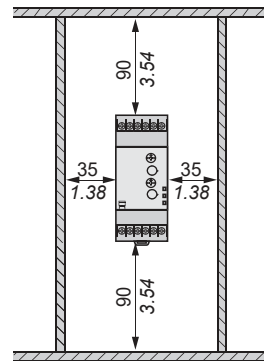

$\frac{\text{mm}}{\text{inch}}$

Supply circuit	Alimentation	Stromversorgung	Alimentación	Alimentazione	
Rated voltage supply Un	Tensions nominales d'alimentation Un	Nennspannung	Tensiones nominales de alimentación Un	Tensioni nominali di alimentazione	~ / — 24...240 V
Inputs and measuring circuit	Entrées et circuit de mesure	Eingänge und Messkreis	Entradas y circuito de medida	Ingressi e circuito di misurazione	
Measuring range	Gamme de mesure	Messbereich	Rangos de medida	Gamme di misurazione	250 Ω...1 MΩ
Measuring subrange	Sous gamme de mesure	Messunterbereich	Sub-gama de medida	Sottogamma di misurazione	LS 250 Ω...5 kΩ St 5 kΩ...100 kΩ HS 50 kΩ...1 MΩ
Timing circuit	Temporisations	Verzögerungen	Temporización	Temporizzazioni	
Threshold overshoot time delay Tt	Temporisation au franchissement du seuil	Timeout beim Über-bzw. Unterschreiten des Schwellwerts Tt	Temporización Tt sobre o bajo carga	Temporizzazione Tt sopra o sotto carico	0,1...5 s 0,1...5 s
Service conditions	Conditions de fonctionnement	Betriebsbedingungen	Condiciones de funcionamiento	Condizioni di funzionamento	
Operating temperature	Température de fonctionnement	Betriebstemperatur	Temperatura de funcionamiento	Temperatura di funzionamento	°C -20...+50 °F -4...+122
Storage temperature	Température de stockage	Lagerungs-temperatur	Temperatura de almacenamiento	Temperatura d'immagazzinamento	°C -40...+70 °F -40...+158
Relative Humidity (non-condensing)	Humidité relative (sans condensation)	Relative Luftfeuchtigkeit (ohne Kondensation)	Humedad relativa (no condensante)	Umidità relativa (senza condensa)	max. 95 %
Pollution Degree Cat III/3	Degré de pollution Cat III/3	Verschmutzungsgrad Kat III/3	Grado de contaminación Cat III/3	Grado d'inquinamento Cat III/3	IEC60664-1/60255-5
Degree of Protection - Terminals : - Housing :	Degré de protection - Bornier : - Boîtier :	Schutzart - Klemme : - Gehäuse :	Grado de protección - Termina : - Caja :	Grado di protezione - Morsettiera : - Involucro :	IP 20 IP 30

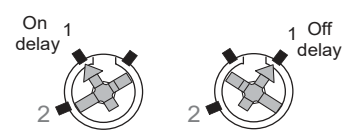
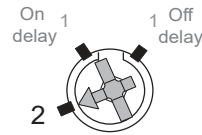
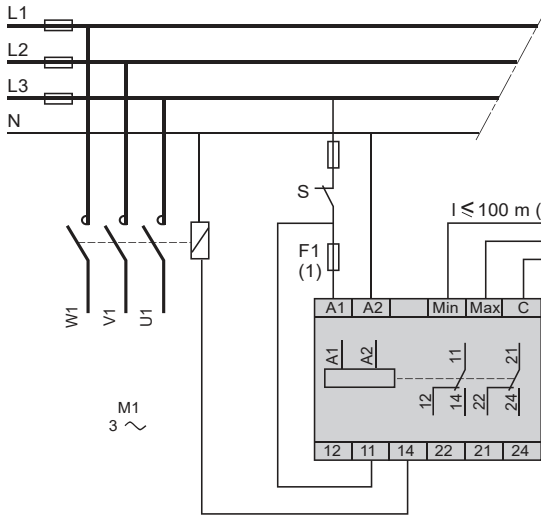

Conducting fluid  
Liquide conducteur  
Lietflüssigkeit  
Líquido conductor  
Liquido conduttore

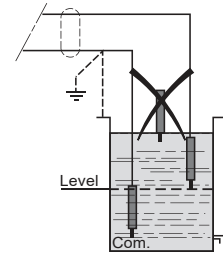

Use only "C" and "Min"  
N'utiliser que "C" et "Min"  
Nur "C" und "Min" verwenden  
Sólo utilizar "C" y "Min"  
Utilizzare solo "C" e "Min"

(1) 1 A fast-acting fuse. UL...Class CC ; IEC...gG / Fusible rapide 1 A. UL...Class CC ; IEC...gG / Schnellsicherung 1 A. UL...Klasse CC ; IEC...gG  
Fusible rápido 1 A. UL...Clase CC ; IEC...gG / Fusibile rapido 1 A. Omologato UL...Classe CC ; IEC...gG

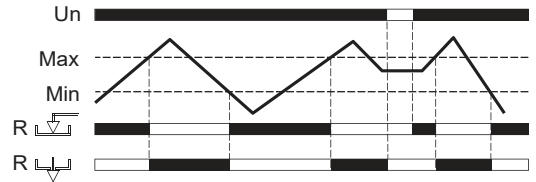
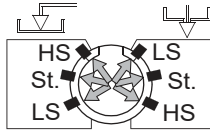
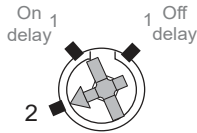
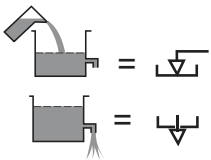

⊗ Off / Eteinte / Erlöschen / Apagado / Spenta

☀ On / Allumée / Brennt / Encendido / Accesa

⚡ Flash / Flash / Flash / Relámpago / Flash



Tt ⊗ Un ⊗ R ⊗	OFF	R	12/22 14/24	11/21
☀ ☀	ON	Max Min	12/22 14/24	11/21
☀ ☀ ☀	ON	Max Min	12/22 14/24	11/21
☀ ☀ ⊗	ON	Max Min	12/22 14/24	11/21



Tt ⊗ Un ⊗ R ⊗	OFF	R	12/22 14/24	11/21
☀ ☀ ☀	ON	Max Min	12/22 14/24	11/21
☀ ☀ ☀	ON	Max Min	12/22 14/24	11/21
☀ ☀ ⊗	ON	Max Min	12/22 14/24	11/21

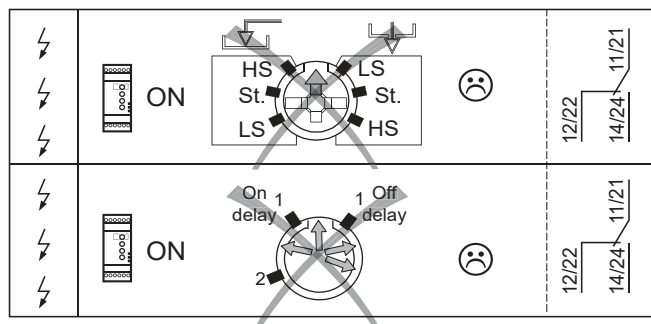

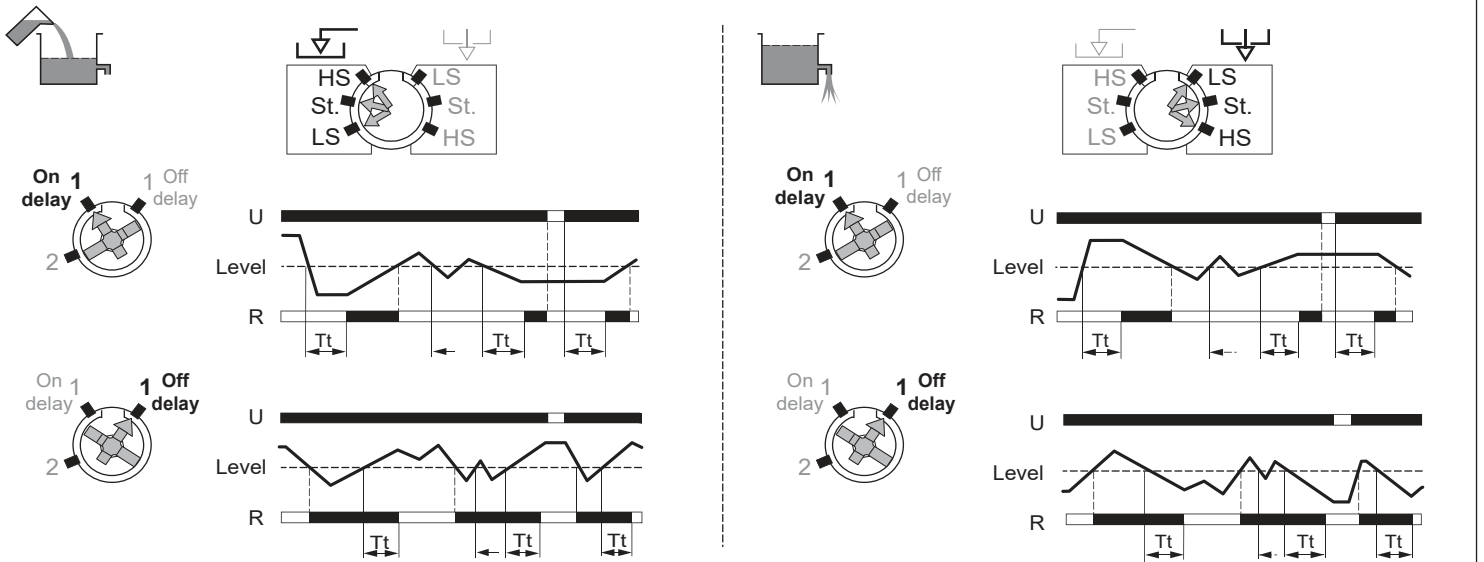

On delay : Control of 1 On delay level. / Contrôle d'1 niveau avec temporisation à l'enclenchement. / Kontrolle von 1 Niveau mit Einschaltverzögerung.

Control de 1 nivel con temporización en el enclavamiento. / Controllo di 1 livello con temporizzazione all'avviamento.

Off delay : Control of 1 Off delay level. / Contrôle d'1 niveau avec temporisation au déclenchement. / Kontrolle von 1 Niveau mit Auslöseverzögerung.

Control de 1 nivel con temporización en el desenchavamiento. / Controllo di 1 livello con temporizzazione allo scatto.

⊗ Off / Eteinte / Erlschen / Apagado / Spenta    ☀ On / Allumée / Brennt / Encendido / Accesa    ⚡ Blinking/ Clignotante / Blinkt / Intermitente / Lampeggiante

Tt ⊗ Un ⊗ R ⊗	OFF	On 1 delay 1 Off delay	R	12/22 14/24 11/21
☀ ☀ ⚡	ON	Level	Tt (1)	12/22 14/24 11/21
☀ ☀ ☀	ON	Level	Tt (2)	12/22 14/24 11/21
☀ ☀ ☀	ON	Level		12/22 14/24 11/21

Tt ⊗ Un ⊗ R ⊗	OFF	On 1 delay 1 Off delay	R	12/22 14/24 11/21
☀ ☀ ⚡	ON	Level	Tt (1)	12/22 14/24 11/21
☀ ☀ ☀	ON	Level	Tt (2)	12/22 14/24 11/21
☀ ☀ ☀	ON	Level		12/22 14/24 11/21

Tt ⊗ Un ⊗ R ⊗	OFF	On 1 delay 1 Off delay	R	12/22 14/24 11/21
☀ ☀ ☀	ON	Level		12/22 14/24 11/21
☀ ☀ ⚡	ON	Level	Tt (1)	12/22 14/24 11/21
☀ ☀ ☀	ON	Level	Tt (2)	12/22 14/24 11/21

Tt ⊗ Un ⊗ R ⊗	OFF	On 1 delay 1 Off delay	R	12/22 14/24 11/21
☀ ☀ ☀	ON	Level		12/22 14/24 11/21
☀ ☀ ⚡	ON	Level	Tt (1)	12/22 14/24 11/21
☀ ☀ ☀	ON	Level	Tt (2)	12/22 14/24 11/21

(1) Time delay in progress / Temporisation en cours / Zeit läuft/Temporización en curso / Temporizzazione in corso.

(2) End of the preset time delay (adjustable on front panel) / Fin de la consigne de temporisation (réglable en façade) / Ende des Sollwerts der Verzögerung (an Frontseite einstellbar) / Fin de la consigna de temporización (ajustable en fachada) / Fine dell'istruzione di temporizzazione (regolabile sul pannello anteriore).